

CyberPower[®]
Reliability. Quality. Value.

User Manual

Power Distribution Unit



CyberPower[®]
Reliability. Quality. Value.

4241 12th Ave E #400,
Shakopee, MN 55379
1-877-297-6937
www.CPSww.com

Table of Contents

Model List	1
PDU Naming Convention	1
Package Contents	2
Safety Precautions	2
Installation	3
Horizontal Installation	3
Vertical Installation with Brackets ...	4
Vertical Installation -	
Keyhole Mounts (0U models only) ...	5
Cord Retention Tray installation	5
Meter Configuration	5
Electrical Installation	6
Troubleshooting	6
Product Features	
Technical Specification	7
Basic Series (1U 20A).....	7
Basic Series (1U 30A).....	8
Basic Series (0U 10A).....	9
Basic Series (0U 20A).....	10
Basic Series (0U 30A).....	11
Metered Series (0U 20A)	12
Metered Series (0U 30A).....	13
Warranty & Service	14

Model List:

Basic Series:

PDU20BHVT8R	PDU20BHVIEC8R
PDU20BHVT10R	PDU20BHVIEC10R
PDU20BHVT12R	PDU20BHVIEC12R
	PDU20BHVIEC12Ra
PDU30BT8F8R	PDU30BHVT8R
PDU30BT10F10R	PDU30BHVT10R
	PDU30BHVT12R

Basic Series (0U):

PDU10BVHVIEC16F	
PDU10BVHVIEC20F	
PDU20BVHVVT16F	PDU20BVHVIEC16F
PDU20BVHVVT20F	PDU20BVHVIEC20F
PDU20BVHVVT24F	PDU20BVHVIEC24F
PDU20BVHVVT32F	PDU20BVHVIEC32F
PDU20BVHVVT38F	PDU20BVHVIEC38F
PDU30BVT14F	PDU30BVHVVT16F
PDU30BVT16F	PDU30BVHVVT20F
PDU30BVT20F	PDU30BVHVVT32F
PDU30BVT28F	PDU30BVHVVT38F
PDU30BVT32F	

Metered Series (0U):

PDU20MVHVT20F	PDU20MVHVIEC24F
PDU20MVHVT30F	PDU20MVHVIEC30F
PDU20MVHVT38F	PDU20MVHVIEC38F
PDU30MVT24F	PDU30MVHVT20F
PDU30MVT32F	PDU30MVHVT30F
	PDU30MVHVT38F

PDU Naming Convention:

PDU	XX	M	V	HV	T	F	R	NET
	1	2	3	4	5	6	7	8

- | | |
|------------------------|--|
| 1. Amperage: | Amperage – 15A, 20A, 30A |
| 2. Series: | B: =Basic M: =Metered
SW: = Switched |
| 3. Rack Space: | NULL: =Horizontal V:= Vertical |
| 4. Input Voltage: | NULL: =120V HV:= High Voltage – 200V to 230V |
| 5. Plug Type: | NULL: =NEMA 5-15P / 5-20P
T: = Twist (NEMA L5-L6 Plug)
IEC:= (IEC C14/C20) |
| 6. Outlet Number Front | Number of Outlets followed by F – Example 8F |
| 7. Outlet Number Rear | Number of Outlets followed by R – Example 8R |
| 8. Network Management | NET |

Package Contents

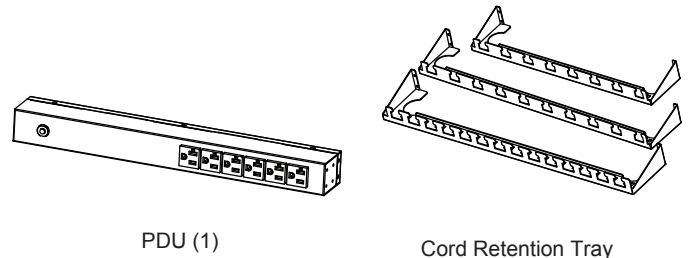

PDU (1)

Cord Retention Tray
(1/2/3/4 pcs - varies by model)

Mounting Brackets

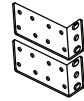

Horizontal Installation
Used (1 set)



Vertical Installation
Used (1 set)

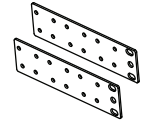

Vertical Mounting Brackets (1 set)
(for 0U models only)



Bracket Mounting
Screws M4 X 8 (4pcs)



Cord Retention Tray
Mounting Screws M3 X 6
(4/8/12/16 pcs - varies by model)

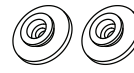

Keyhole Mounting Pegs (2pcs)
with Screws M4 X 8 (2pcs)
(for 0U models only)



Cord Retainer Clips (8/10/12/14/16/
20/24/30/32/38 pcs - varies by model)
for Cord Retention Tray



Ground Screw M5 X 6 (1 pcs)

Documentation:



User Manual



Product Registration Card



Check

Before using, please check to ensure the package contains all the items shown above. If there are missing parts please contact CyberPower technical support at www.CPSww.com or call 1-877-297-6937.

Safety Precautions - Read the following before installing or operating the Power Distribution Unit (PDU):

1. Use only the supplied hardware to attach the mounting brackets.
2. The PDU must only be plugged into a three-wire, grounded outlet on a circuit protected by a fuse or circuit breaker. Connection to any other type of power outlet may result in a shock hazard.
3. Do not use extension cords or adapters with this PDU.
4. Never install a PDU, or associated wiring or equipment, during a lightning storm.
5. Check that the power cord, plug, and socket are in good condition.
6. The socket-outlet shall be installed near the equipment and shall be easily accessible.
7. **CAUTION!** To prevent the risk of fire or electric shock, this PDU should be installed in a temperature and humidity controlled indoor area free of conductive contaminants. Do not install this PDU where excessive moisture or heat is present..

Installation

Horizontal Installation (1U models only)

Step 1 – Mounting bracket installation

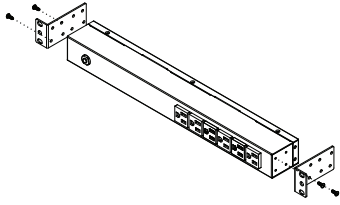

Install the screws (M4 X 8) in holes diagonal from each other.

Step 2 – PDU Mounting

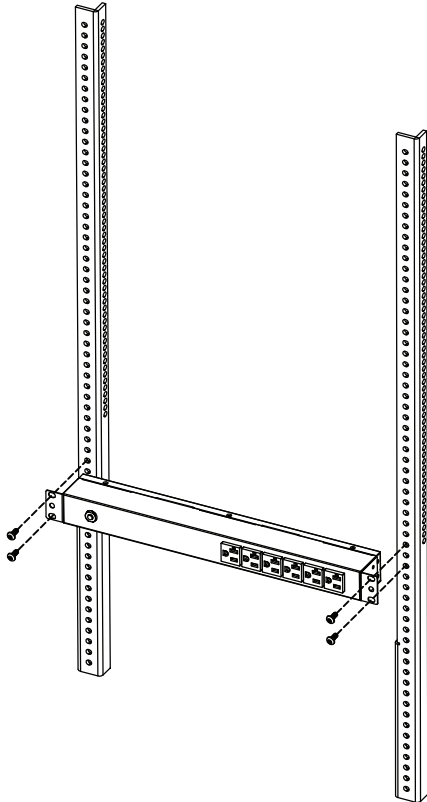

Install the PDU using fasteners compatible with the rack.

Vertical Installation with Brackets

Step 1 – Mounting bracket installation

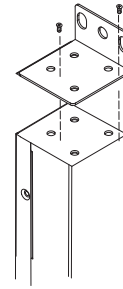

Install the screws (M4 X 8) in holes diagonal from each other.

Step 2 – PDU Mounting

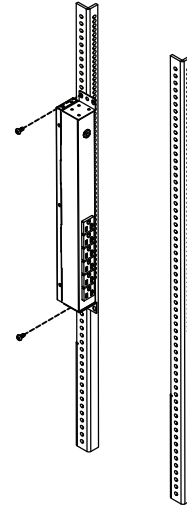

Install the PDU using fasteners compatible with the rack.

Vertical Installation with Brackets (0U models only)

Step 1 – Mounting bracket installation

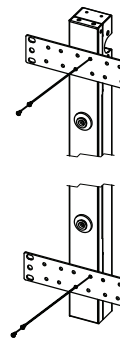

Attach the Vertical Mounting Brackets to the PDU with the 4 supplied Bracket Mounting Screws (M4 X 8).

Step 2 – PDU Mounting

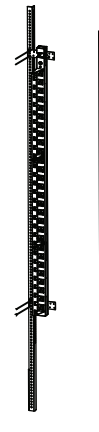

Install the PDU using fasteners compatible with the rack.

Vertical Installation with Keyhole Mounts (0U Models)

Step 1 – Keyhole Mount installation

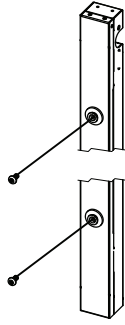

Attach the Keyhole Mounting Pegs to the PDU with the 2 supplied Bracket Mounting Screws (M4 X 8).

Step 2 – PDU Mounting

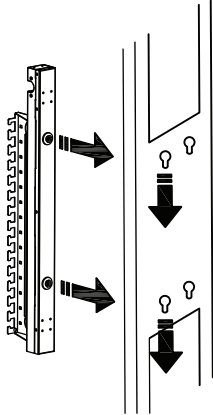

Align the the Keyhole Mounts to the Keyhole Slots on the rack. Insert and slide down to lock firmly into place.

Cord Retention Tray installation (Optional for both horizontal and vertical installations)

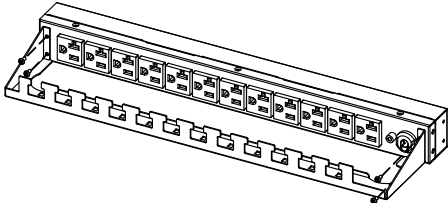

Attach the Cord Retention Tray to the PDU with the 4 supplied Cord Retention Tray Mounting Screws (M3 X 6).

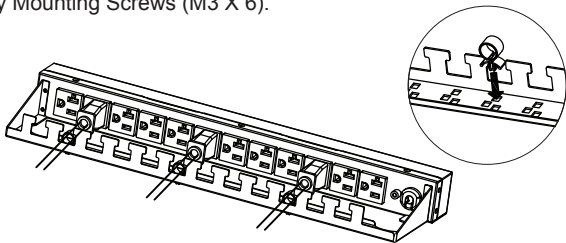

Attach the Cord Retainer Clips to the Cord Retention Tray.

Meter Configuration



Depending on installation method (vertical or horizontal), the LED Meter may need to be rotated, before installation, for proper orientation.

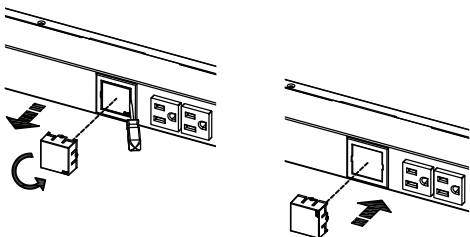

Use a screwdriver to gently remove the LED Meter. Rotate the LED Meter 90 degrees, and insert back into the PDU.

Electrical Installation

Step 1 – Receptacle evaluation

Ensure that the plug type of your PDU unit (e.g. NEMA 5-15P, NEMA 5-20P, NEMA L5-30P) matches the wall receptacle type that you are using.



PDU must be plugged into a three-wire, grounded wall receptacle only. The wall receptacle must also be connected to an appropriate branch circuit/main with fuse or circuit breaker protection. Connection to any other type of wall receptacle may result in a shock hazard.

Step 2 – Plug the PDU into the wall receptacle

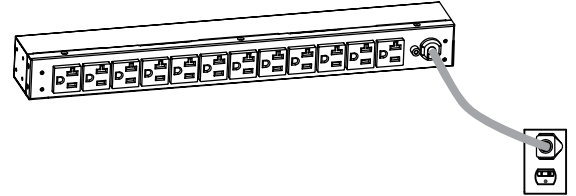

Step 3 – Attach equipment

Before attaching equipment, it is important to calculate the total load that you will be placing on the PDU. It is extremely important not to exceed the PDU's maximum current load (as outlined in the Specifications section). In order to determine your total load, simply add up the amperage of your devices and ensure that it does not exceed the unit's capacity.

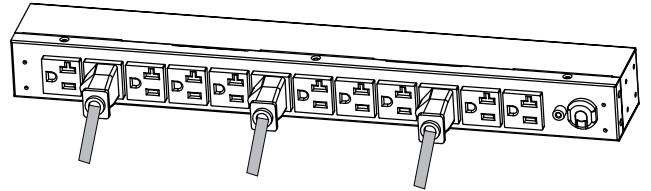

Troubleshooting

Problem	Possible Cause	Solution
PDU Outlets do not provide power to connected equipment	1. Open breaker 2. Loose power cord	Reset Breaker check if plug is completely connected. If the problem remains contact tech support.
Amperage displayed on Amperage Meter exceeds the unit's capability (Metered type only)	1. Overload 2. Amperage meter is damaged	The meter will flash when overloaded. Reduce the load on the PDU until the overload is gone. If the problem remains contact tech support.
Circuit breaker has tripped	1. Sustained overload 2. Excessive ambient or internal temperatures. 3. Faulty breaker	Reset Breaker. If the problem remains contact tech support.

Basic Series (1U 20A)

Product Features

Front View

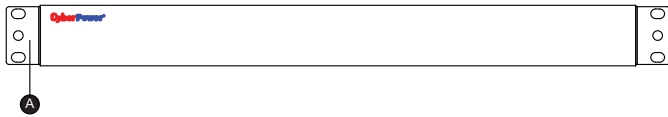

A. Mounting Bracket

Back View

Twist Type

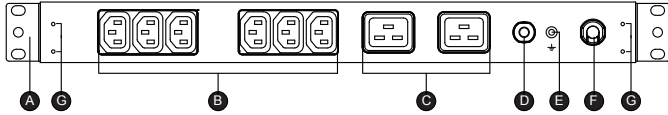

A. Mounting Bracket
B. Rear Outlets (IEC 320 C13)
C. Rear Outlets (IEC 320 C19)
D. Circuit Breaker
E. External Site Ground
F. AC Power Cord
G. Cord Retention Tray Screw Holes

IEC Type

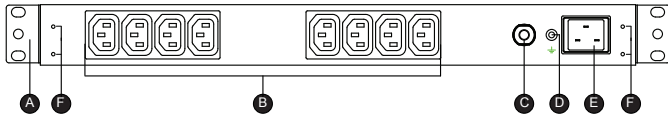

A. Mounting Bracket
B. Rear Outlets (IEC 320 C13)
C. Circuit Breaker
D. External Site Ground
E. AC Inlet (IEC 320 C20)
F. Cord Retention Tray Screw Holes

Technical Specifications

Model Name	PDU20BHVT8R PDU20BHVT10R PDU20BHVT12R	PDU20BHVIC8R PDU20BHVIC10R PDU20BHVIC12R PDU20BHVIC12Ra
Input		
Voltage	200~230V	
Max Current	20 A	
Regulatory Derated Input Current	16 A	
Circuit Breaker	16 A	
Plug Type	NEMA L6-20P	IEC 320 C20
Power Cord Length	10 ft	
Output		
Voltage	200~230V	
Max Current	20 A	
Outlet Type(Quantity)	IEC 320 C19(2)/C13(6) IEC 320 C19(2)/C13(8) IEC 320 C13(12)	IEC 320 C13(8) IEC 320 C13(10) IEC 320 C13(12) IEC 320 C19(2)/C13(10)
Indicators		
LED Indicators	N/A	
Meter Readout	N/A	
Physical		
Dimension (WxDxH)	17.5" x 1.5" x 1.75" / 44.5 x 3.81 x 4.45 cm	
Environmental		
Humidity	Operating 0 to 95% Non-condensing Non-Operating 0 to 95% Non-condensing	
Altitude	Operating 0ft to 10,000ft Non-Operating 0ft to 50,000ft	
Temperature	Operating 32F to 95F Non-Operating 5F to 113F	
Safety Approvals		
Certifications	ETL (test followed UL 60950-1) RoHS	
Warranty	Lifetime	

Basic Series (1U 30A)

Product Features

Front View

Normal Type

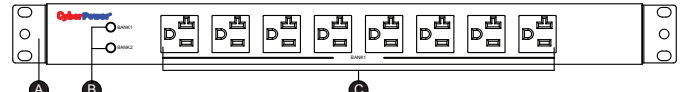

A. Mounting Bracket
B. LED Indicators
C. Front Bank 1 Outlets

High Voltage Type

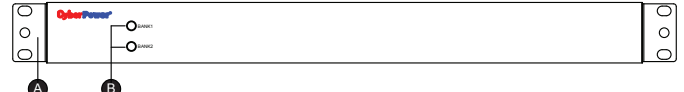

A. Mounting Bracket
B. LED Indicators

Back View

Normal Type

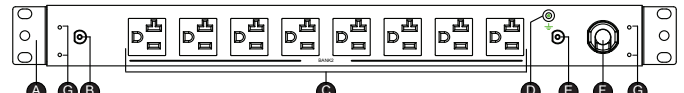

A. Mounting Bracket
B. Circuit Breaker
C. Rear Bank 2 Outlets
D. External Site Ground
E. Circuit Breaker (Bank 2)
F. AC Power Cord
G. Cord Retention Tray Screw Holes

High Voltage Type

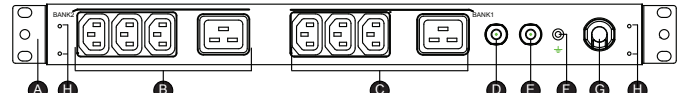

A. Mounting Bracket
B. Bank 2 Outlets
C. Bank 1 Outlets
D. Circuit Breaker (Bank 2)
E. Circuit Breaker (Bank 1)
F. External Site Ground
G. AC Power Cord
H. Cord Retention Tray Screw Holes

Technical Specifications

Model Name	PDU30BT8F8R PDU30BT10F10R	PDU30BHVT8R PDU30BHVT10R PDU30BHVT12R
Input		
Voltage	100 ~ 125 V	200~230V
Max Current	30 A	
Regulatory Derated Input Current	24A	
Circuit Breaker	20 A x 2	16 A x 2
Plug Type	NEMA L5-30P	NEMA L6-30P
Power Cord Length	12 ft	10 ft
Output		
Voltage	100~125 V	200~230V
Max Current	30 A	
Outlet Type(Quantity)	NEMA 5-20R(16) NEMA 5-20R(20)	IEC 320 C19(2)/C13(6) IEC 320 C19(2)/C13(8) IEC 320 C13(12)
Indicators		
LED Indicators	Bank1(GREEN) · Bank2(GREEN)	
Meter Readout	N/A	
Physical		
Dimension (WxDxH)	17.5"x2.25"x1.75" / 44.5x5.72x4.45 cm	17.5"x1.5"x1.75" / 44.5x3.81x4.45 cm
Environmental		
Humidity	Operating 0 to 95% Non-condensing Non-Operating 0 to 95% Non-condensing	
Altitude	Operating 0ft to 10,000ft Non-Operating 0ft to 50,000ft	
Temperature	Operating 32F to 95F Non-Operating 5F to 113F	
Safety Approvals		
Certifications	ETL (test followed UL 60950-1) RoHS	
Warranty	Lifetime	

Basic Series (0U 10A)

Product Features

Front View

Back View

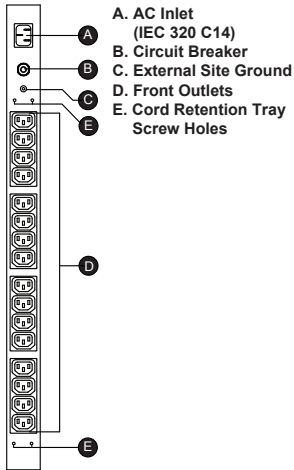

- A. AC Inlet (IEC 320 C14)
- B. Circuit Breaker
- C. External Site Ground
- D. Front Outlets
- E. Cord Retention Tray Screw Holes

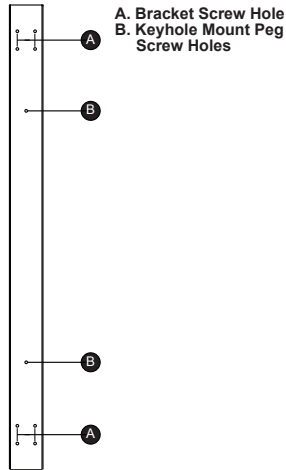

- A. Bracket Screw Hole
- B. Keyhole Mount Peg Screw Holes

Technical Specifications

Model Name	PDU10BVHVIEC16F PDU10BVHVIEC20F
Input	
Voltage	200~230V
Max Current	10 A
Input Current	10 A
Circuit Breaker	10 A
Plug Type	IEC C14
Power Cord Length	10 ft
Output	
Voltage	200~230V
Max Current	10 A
Outlet Type(Quantity)	IEC 320 C13(16) IEC 320 C19(4)/C13(16)
Indicators	
LED Indicators	N/A
Meter Readout	N/A
Physical	
Dimension (WxDxH)	1.75"x1.5"x24" / 4.45x3.81x60.96 cm 1.75"x1.5"x36" / 4.45x3.81x91.44 cm
Environmental	
Humidity	Operating 0 to 95% Non-condensing Non-Operating 0 to 95% Non-condensing
Altitude	Operating 0ft to 10,000ft Non-Operating 0ft to 50,000ft
Temperature	Operating 32F to 95F Non-Operating 5F to 113F
Safety Approvals	
Certifications	ETL (test followed UL 60950-1) RoHS
Warranty	Lifetime

Basic Series (0U 20A)

Product Features

Front View

Back View

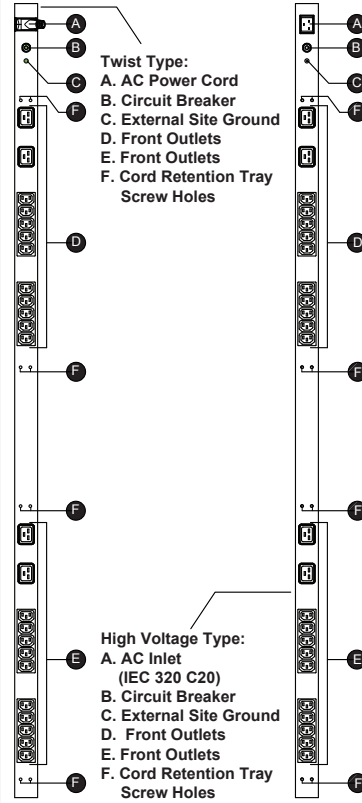

- Twist Type:**
- A. AC Power Cord
 - B. Circuit Breaker
 - C. External Site Ground
 - D. Front Outlets
 - E. Front Outlets
 - F. Cord Retention Tray Screw Holes

- High Voltage Type:**
- A. AC Inlet (IEC 320 C20)
 - B. Circuit Breaker
 - C. External Site Ground
 - D. Front Outlets
 - E. Front Outlets
 - F. Cord Retention Tray Screw Holes

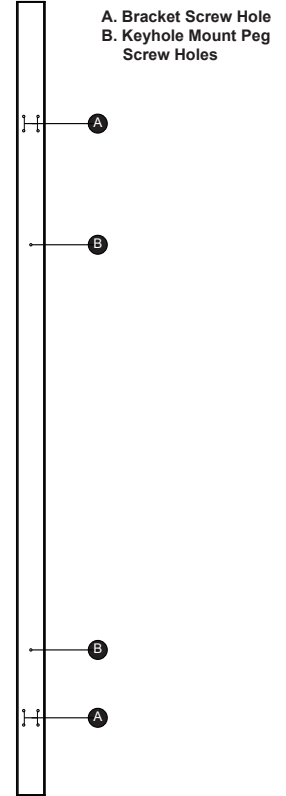

- A. Bracket Screw Hole
- B. Keyhole Mount Peg Screw Holes

Technical Specifications

Model Name	PDU20BVHVT16F PDU20BVHVT20F PDU20BVHVT24F PDU20BVHVT32F PDU20BVHVT38F	PDU20BVHVIEC16F PDU20BVHVIEC20F PDU20BVHVIEC24F PDU20BVHVIEC32F PDU20BVHVIEC38F
Input		
Voltage	200~230V	
Max Current	20 A	
Regulatory Derated Input Current	16 A	
Circuit Breaker	16 A	
Plug Type	NEMA L6-20P	IEC 320 C20
Power Cord Length	10 ft	
Output		
Voltage	200~230V	
Max Current	20 A	
Outlet Type(Quantity)	IEC 320 C13(16) IEC 320 C19(4)/C13(16) IEC 320 C19(4)/C13(20) IEC 320 C19(8)/C13(24) IEC 320 C19(8)/C13(30)	
Indicators		
LED Indicators	N/A	
Meter Readout	N/A	
Physical		
Dimension (WxDxH)	1.75" x 1.5" x 24" / 4.45 x 3.81 x 60.96 cm 1.75" x 1.5" x 36" / 4.45 x 3.81 x 91.44 cm 1.75" x 1.5" x 48" / 4.45 x 3.81 x 121.92cm 1.75" x 1.5" x 60" / 4.45 x 3.81 x 152.40 cm 1.75" x 1.5" x 70" / 4.45 x 3.81 x 177.80 cm	
Environmental		
Humidity	Operating 0 to 95% Non-condensing Non-Operating 0 to 95% Non-condensing	
Altitude	Operating 0ft to 10,000ft Non-Operating 0ft to 50,000ft	
Temperature	Operating 32F to 95F Non-Operating 5F to 113F	
Safety Approvals		
Certifications	ETL (test followed UL 60950-1) RoHS	
Warranty	Lifetime	

Basic Series (0U 30A)

Product Features

Front View

Back View

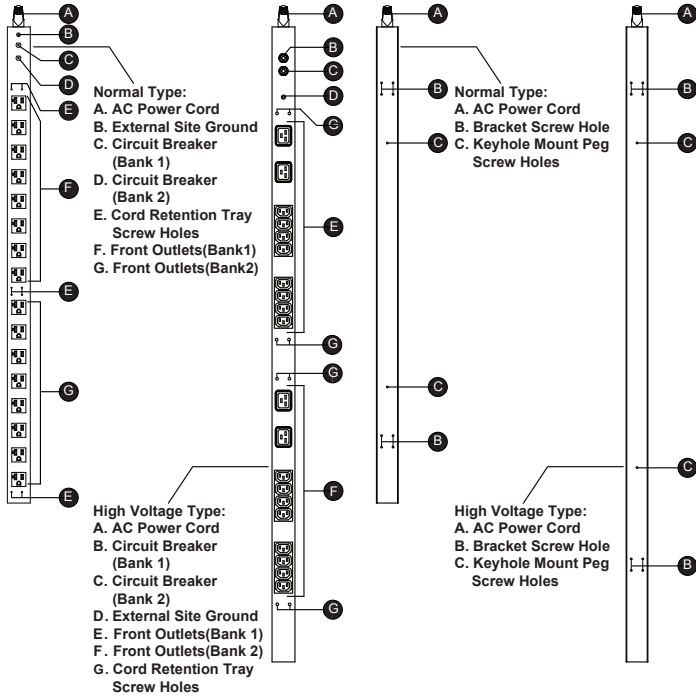

Technical Specifications

Model Name	PDU30BVT14F PDU30BVT16F PDU30BVT20F PDU30BVT28F PDU30BVT32F	PDU30BVHVT16F PDU30BVHVT20F PDU30BVHVT32F PDU30BVHVT38F
Input		
Voltage	100 ~ 125 V	200~230V
Max Current	30 A	
Regulatory Derated Input Current	24A	
Circuit Breaker	20 A x 2	16 A x 2
Plug Type	NEMA L5-30P	NEMA L6-30P
Power Cord Length	10 ft	
Output		
Voltage	100 ~ 125 V	200~230V
Max Current	30 A	
Outlet Type(Quantity)	NEMA 5-20R(14) NEMA 5-20R(16) NEMA 5-20R(20) NEMA 5-20R(28) NEMA 5-20R(32)	IEC 320 C13(16) IEC 320 C19(4)/C13(16) IEC 320 C19(8)/C13(24) IEC 320 C19(8)/C13(30)
Indicators		
LED Indicators	N/A	
Meter Readout	N/A	
Physical		
Dimension (WxDxH)	1.75"x2.25"x24" / 4.45x5.72x60.96 cm 1.75"x2.25"x36" / 4.45x5.72x91.44 cm 1.75"x2.25"x48" / 4.45x5.72x121.92cm 1.75"x2.25"x60" / 4.45x5.72x152.40 cm 1.75"x2.25"x70" / 4.45x5.72x177.80 cm	1.75"x1.5"x24" / 4.45x3.81x60.96 cm 1.75"x1.5"x36" / 4.45x3.81x91.44 cm 1.75"x1.5"x60" / 4.45x3.81x152.40 cm 1.75"x1.5"x70" / 4.45x3.81x177.80 cm
Environmental		
Humidity	Operating 0 to 95% Non-condensing Non-Operating 0 to 95% Non-condensing	
Altitude	Operating 0ft to 10,000ft Non-Operating 0ft to 50,000ft	
Temperature	Operating 32F to 95F Non-Operating 5F to 113F	
Safety Approvals		
Certifications	ETL (test followed UL 60950-1) RoHS	
Warranty	Lifetime	

Meter Series (0U 20A)

Product Features

Front View

Back View

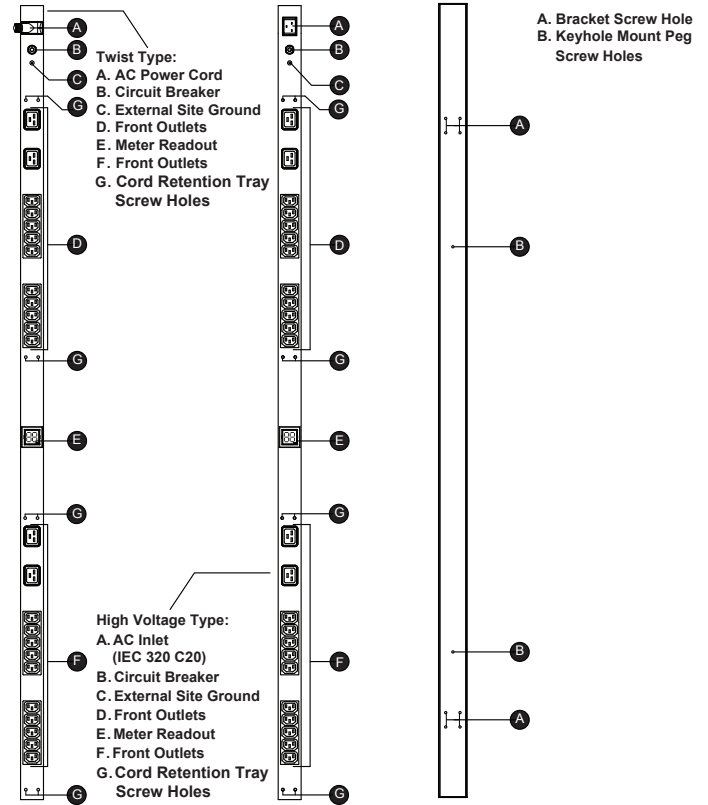

Technical Specifications

Model Name	PDU20MVHVT20F PDU20MVHVT30F PDU20MVHVT38F	PDU20MVHVIC24F PDU20MVHVIC30F PDU20MVHVIC38F
Input		
Voltage	200~230V	
Max Current	20 A	
Regulatory Derated Input Current	16 A	
Circuit Breaker	16 A	
Plug Type	NEMA L6-20P	IEC 320 C20
Power Cord Length	10 ft	
Output		
Voltage	200~230V	
Max Current	20 A	
Outlet Type(Quantity)	IEC 320 C19(4)/C13(16) IEC 320 C19(6)/C13(24) IEC 320 C19(8)/C13(30)	IEC 320 C19(4)/C13(20) IEC 320 C19(6)/C13(24) IEC 320 C19(8)/C13(30)
Indicators		
LED Indicators	N/A	
Meter Readout	Amperage	
Physical		
Dimension (WxDxH)	1.75" x 1.5" x 48" / 4.45 x 3.81 x 121.92 cm 1.75" x 1.5" x 60" / 4.45 x 3.81 x 152.40 cm 1.75" x 1.5" x 70" / 4.45 x 3.81 x 177.80 cm	
Environmental		
Humidity	Operating 0 to 95% Non-condensing Non-Operating 0 to 95% Non-condensing	
Altitude	Operating 0ft to 10,000ft Non-Operating 0ft to 50,000ft	
Temperature	Operating 32F to 95F Non-Operating 5F to 113F	
Safety Approvals		
Certifications	ETL (test followed UL 60950-1) RoHS	
Warranty	Lifetime	

Metered Series (0U 30A)

Product Features

Front View

Back View

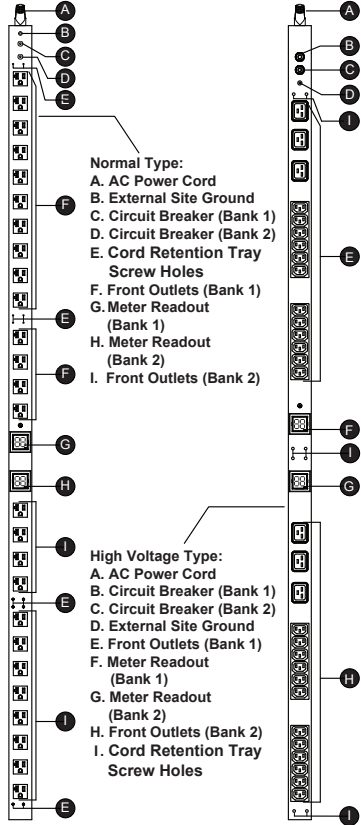

- A. AC Power Cord
- B. Bracket Screw Hole
- C. Keyhole Mount Peg Screw Holes

- Normal Type:**
- A. AC Power Cord
 - B. External Site Ground
 - C. Circuit Breaker (Bank 1)
 - D. Circuit Breaker (Bank 2)
 - E. Cord Retention Tray Screw Holes
 - F. Front Outlets (Bank 1)
 - G. Meter Readout (Bank 1)
 - H. Meter Readout (Bank 2)
 - I. Front Outlets (Bank 2)

- High Voltage Type:**
- A. AC Power Cord
 - B. Circuit Breaker (Bank 1)
 - C. Circuit Breaker (Bank 2)
 - D. External Site Ground
 - E. Front Outlets (Bank 1)
 - F. Meter Readout (Bank 1)
 - G. Meter Readout (Bank 2)
 - H. Front Outlets (Bank 2)
 - I. Cord Retention Tray Screw Holes

Technical Specifications

Model Name	PDU30MVT24F PDU30MVT32F	PDU30MVHVT20F PDU30MVHVT30F PDU30MVHVT38F
Input		
Voltage	100 ~ 125 V	200~230V
Max Current	30 A	
Regulatory Derated Input Current	24A	
Circuit Breaker	20 A x 2	16 A x 2
Plug Type	NEMA L5-30P	NEMA L6-30P
Power Cord Length	10 ft	
Output		
Voltage	100 ~ 125 V	200~230V
Max Current	30 A	
Outlet Type(Quantity)	NEMA 5-20R(24) NEMA 5-20R(32)	IEC 320 C19(4)/C13(16) IEC 320 C19(6)/C13(24) IEC 320 C19(8)/C13(30)
Indicators		
LED Indicators	N/A	
Meter Readout	2 Amperage	
Physical		
Dimension (WxDxH)	1.75"x2.25"x60" / 4.45x5.72x152.40 cm 1.75"x2.25"x70" / 4.45x5.72x177.80 cm	1.75"x1.5"x48" / 4.45x3.81x121.92 cm 1.75"x1.5"x60" / 4.45x3.81x152.40 cm 1.75"x1.5"x70" / 4.45x3.81x177.80 cm
Environmental		
Humidity	Operating 0 to 95% Non-condensing Non-Operating 0 to 95% Non-condensing	
Altitude	Operating 0ft to 10,000ft Non-Operating 0ft to 50,000ft	
Temperature	Operating 32F to 95F Non-Operating 5F to 113F	
Safety Approvals		
Certifications	ETL (test followed UL 60950-1) RoHS	
Warranty	Lifetime	

Product Registration

Thank you for purchasing a CyberPower product. Prompt product registration entitles coverage under the Limited Warranty and also allows the opportunity to be notified of product enhancements, upgrades, and other announcements.

Registration is quick and easy at www.cpsww.com/register.

Need Additional Help?

Feel free to contact our Tech Support department with installation, troubleshooting, or general product questions.

CyberPower Technical Support
 Phone: 1-877-297-6937
 Email: tech@cpsww.com
 Web: www.CPSww.com
 Mail: 4241 12th Avenue E, Suite 400 Shakopee, MN 55379

Hours of Operation: Monday – Friday, 8:00am – 5:00pm (CST)

Limited Warranty

Read the following terms and conditions carefully before using the CyberPower PDU(the "Product"). By using the Product you consent to be bound by and become a party to the terms and conditions of this Limited Warranty (together referred to as this "Warranty"). If you do not agree to the terms and conditions of this Warranty, you should return the Product for a full refund prior to using it.

Who is Providing this Warranty?

CyberPower Systems (USA), Inc. ("CyberPower") provides this Limited Warranty.

What Does This Warranty Cover?

This warranty covers defects in materials and workmanship in the Product under normal use and conditions.

What is the Period of Coverage?

This Warranty is for as long as the original owner owns the Product.

Who Is Covered?

This warranty only covers the original purchaser. Coverage ends if you sell or otherwise transfer the Product.

How Do You Get Service?

1. Call us at (877) 297-6937 or write to us at Cyber Power Systems (USA), Inc., 4241 12th Ave. E., STE 400, Shakopee, MN 55379 or send us an e-mail message at claims@cyberpowersystems.com for instructions.
2. When you contact CyberPower, identify the Product, the Purchase Date, and the item(s) of Connected Equipment. Have information on all applicable insurance or other resources of recovery/payment that are available to the Initial Customer and Request a Claim Number.
3. You must provide a purchase receipt (or other proof of the original purchase) and provide a description of the defect.
4. Pack and ship the product to CyberPower and, if requested, the item(s) of Connected Equipment, a repair cost estimate for the damage to the Connected Equipment, and all claim forms that CyberPower provides to you. Show the Claim Number on the shipping label or include it with the product. You must prepay all shipping costs, you are responsible for packaging and shipment, and you must pay the cost of the repair estimate.

What Will We Do To Correct Problems?

CyberPower will inspect and examine the Product.

If the Product is defective in material or workmanship, CyberPower will repair or replace it at CyberPower's expense, or, if CyberPower is unable to or decides not to repair or replace the Product (if defective) within a reasonable time, CyberPower will refund to you the full purchase price you paid for the Product (purchase receipt showing price paid is required).

Who Pays For Shipping?

We pay when we send items to you; you pay when you send items to us.

What Are Some Things This Warranty Does Not Cover?

1. This Warranty does not cover any software that was damaged or needs to be replaced due to the failure of the Product or any data that is lost as a result of the failure or the restoration of data or records, or the reinstallation of software.
2. This Warranty does not cover or apply to: misuse, modification, operation or storage outside environmental limits of the Product or the equipment connected to it, nor for damage while in transit or in storage, nor if there has been improper operation or maintenance, or use with items not designed or intended for use with the Product, such as laser printers, appliances, aquariums, medical or life support devices, etc.

What are the Limitations?

1. This Warranty does not apply unless the Product and the equipment that was connected to it were connected to properly wired and grounded outlets (including compliance with electrical and safety codes of the most current electrical code), without the use of any adapters or other connectors.
2. The Product must have been plugged directly into the power source and the equipment connected to the Product must be directly connected to the Product and not "daisy-chained" together in serial fashion with any extension cords, another Product or device similar to the Product, surge suppressor, or power tap. Any such installation voids the Limited Warranty.
3. The Product and equipment connected to it must have been used properly in a suitable and proper environment and in conformance with any license, instruction manual, or warnings provided with the Product and the equipment connected to it.
4. The Product must have been used at all times within the limitations on the Product's VA capacity.
5. The sole and exclusive remedies of the Initial Customer are those provided by this Warranty.

Contact Information

CyberPower Systems, Inc.
4241 12th Ave. East
Suite 400
Shakopee, MN 55379
Phone: (952) 403-9500
Toll-free: (877) 297-6937

CyberPower is the warrantor under this Limited Warranty.
You may also contact CyberPower on the web at CPSww.com.